

Copyright Information

Copyright © 2008 by LAUNCH TECH. CO., LTD. All rights reserved. No part of this publication may be reproduced, stored in a retrieval system, or transmitted in any form or by any means, electronic, mechanical, photocopying, recording or otherwise, without the prior written permission of LAUNCH. The information contained herein is designed only for the use of this unit. LAUNCH is not responsible for any use of this information as applied to other units.

Neither LAUNCH nor its affiliates shall be liable to the purchaser of this unit or third parties for damages, losses, costs, or expenses incurred by purchaser or third parties as a result of: accident, misuse, or abuse of this unit, or unauthorized modifications, repairs, or alterations to this unit, or failure to strictly comply with LAUNCH operating and maintenance instructions. LAUNCH shall not be liable for any damages or problems arising from the use of any options or any consumable products other than those designated as Original LAUNCH Products or LAUNCH Approved Products by LAUNCH.

Trademark Information

LAUNCH is a registered trademark of LAUNCH TECH CO., LTD. (also called LAUNCH for short) in China and other countries. All other LAUNCH trademarks, service marks, domain names, logos, and company names referred to in this manual are either trademarks, registered trademarks, service marks, domain names, logos, company names of or are otherwise the property of LAUNCH or its affiliates. In countries where any of the LAUNCH trademarks, service marks, domain names, logos and company names are not registered, LAUNCH claims other rights associated with unregistered trademarks, service marks, domain names, logos, and company names. Other products or company names referred to in this manual may be trademarks of their respective owners. You may not use any trademark, service mark, domain name, logo, or company name of LAUNCH or any third party without permission from the owner of the applicable trademark, service mark, domain name, logo, or company name. You may

contact LAUNCH by visiting Launch at www.cnlaunch.com, or writing to LAUNCH TECH. CO., LTD., Launch Industrial Park, North of Wuhe Avenue, Banxuegang, Bantian, Longgang, Shenzhen, Guangdong, P.R.China, to request written permission to use Materials on this manual for purposes or for all other questions relating to this manual.

General Notice

- Other product names used herein are for identification purposes only and may be trademarks of their respective owners. LAUNCH disclaims any and all rights in those marks.
- There is a possibility that this unit is inapplicable to some of the vehicle models or systems listed in the diagnostic section due to different countries, areas, and/or years. Do not hesitate to contact LAUNCH if you come across such questions. We are to help you solve the problem as soon as possible

Contents

1 Introduction	1
2 X-431Diagun.....	2
2.1 X-431Diagun Component Descriptions	2
2.2 Port and Indicator Descriptions	2
2.3 X-431Diagun General Components	3
2.4 X-431Diagun Specifications	6
2.5 X-431Diagun Start	7
2.5.1 Power on	7
2.5.2 Calibrate Touch Screen	8
2.5.3 Taskbar	9
2.6 Charge	10
2.6.1 Description of the Power Indicator State	10
2.6.2 Description of the Battery State	10
3 Use X-431Diagun to Diagnose vehicle	13
3.1 Automotive Diagnosis Preparation and Connection.....	13
3.1.1 X-431Diagun preparations	13
3.1.2 TF Card Installation	13
3.1.3 Connect X-431Diagun.....	14
3.2 Begin to Diagnose Vehicle	16
3.2.1 Diagnostic Program.....	17
3.3 How to Diagnose.....	19
3.3.1 Read Fault Code	20
3.3.2 Erase Fault Code.....	22
3.3.3 Read Datastream	23
3.3.4 Actuation Test	25
3.3.5 Driving Record Administration	27
3.5 How to diagnose two cars at the same time	29

3.5.1 Read the datastream of the first car.....	29
3.5.2 Read the datastream of the sencod car.....	32
3.5.3 Comparison and Analysis of Datastream	34
4 Update of Diagnostic Software	35
4.1 User Registration	35
4.2 Member Login	38
4.3 Software Download.....	39
4.4 Software Update	42
4.4.1 Direct Update.....	42
4.4.2 Indirect Update.....	45
4.5 Software Purchase and Update	47
5 FAQ.....	50

1 Introduction

X-431Diagun is a newly developed wireless diagnostic computer with full color display screen. It is a product integrated with automotive electronic technology application and information network technology. "Portable Vehicle Fault Diagnosis Technology" is an advanced vehicle diagnosis technology first created and advocated by Launch and represents the highest level of vehicle diagnosis technology in the world. This is also the development trend and the best solution of this field in the future. X-431Diagun can test almost all the domestic cars and the imported ones from Asia, Europe and America. X-431Diagun diagnoses two cars at the same time, compares and analyzes the data to find the fault. Its features are high quality test, upgrading fast any where at any time and synchronized with the newest international models. Compared with other products, it has high quality and performance. The printer, connected with X-431Diagun through USB port, prints the diagnosis result in real time and the TF card with large capacity stores the diagnosis result. Compared with other diagnostic tools, it has better quality and performance. X-431Diagun has an external printer to print the diagnostic result through a standard USB port. And its TF card with large capacity can store the diagnostic result in real time. Its features are smart design, portable, full color touch screen, easy to operate, supporting multiple languages and wide-range use. Also wireless connection and data communication are realized by Bluetooth and easy to operate.

2 X-431Diagun

2.1 X-431Diagun Component Descriptions

X-431Diagun includes: X-431Diagun main unit and X-431Diagun connector. The communication between X-431Diagun main unit and X-431Diagun connector is through wireless Blue Tooth (also supports wire connection).



Figure 2-1X-431Diagun Front View

2.2 Port and Indicator Descriptions

Figure 2-3 is for each port and indicator of X-431Diagun:



Figure 2-3 X-431Diagun main unit port and indicator



Diagram 2-1 X-431Diagun port and indicator descriptions

①	Power	②	Earphone Hole
③	TF card slot	④	Diagnostic Interface & USB
⑤	Lanyard	⑥	Diagnostic Connector
⑦	Blue tooth LED (blue)	⑧	Power LED (red)
⑨	USB	⑩	Stylus
⑪	Touch screen		

2.3 X-431Diagun General Components

Diagram 2-2 is for each component.

No.	Name	Description	Picture
1	X-431Diagun main unit	Main unit screen contains operation buttons, test result and help.	
2	X-431Diagun connector	Diagnostic box with OBD II -16	
3	X-431Diagun main unit diagnostic cable	to connect X-431Diagun main unit and X-431Diagun connector	
4	Diagnostic adaptor	to connect X-431Diagun connector and 16PIN extension cable	
5	Stylus	for click operation of X-431Diagun	
6	Battery Charger	to transform 100-240V AC to 5V DC	
7	TF card	to store diagnostic program and data	
8	TF card reader	to read and store data from TF card through PC, used to upgrade on the network	

9	USB cable	to connect X-431Diagun main unit and PC, used to upgrade on the network with wire connection	
10	Printer cable	to connect the X-431Diagun main unit and the printer	
11	Haversack	to place X-431Diagun main unit and X-431Diagun connector, etc.	(Optional)
12	non-16PIN diagnostic connector (Several)	for diagnostic connector of special model (Optional)	(Optional)

2.4 X-431Diagun Specifications

Operating System: WIN CE 5.0

CPU: 400 MHz ARM9

Memory Card: 1G TF

Main Unit: Universal Serial Bus/USB

Main Unit Power: DC5V

Printer Interface: USB

Display Screen: 480X272, 4.3-inch LCD with touch

Rechargeable Battery: 1530 mAh

Bluetooth: theoretically 100m, actually 15-20m

Upgrading Interface: USB

In addition, it also supports wire communication method and external memory extension.

2.5 X-431Diagun Start

2.5.1 Power on



Press [POWER] key in the top right-hand corner of the main unit top. Main unit will display the initialization screen, as shown on the left.

Note: Power off by pressing [POWER] key for 5 seconds at least.

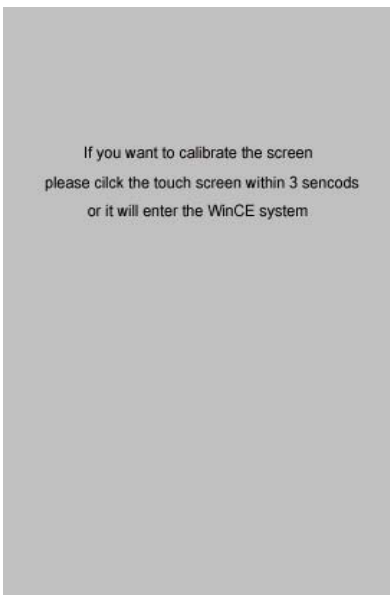

After reading the system bar on the initialization screen, operate following the indication, as shown on the left.

2.5.2 Calibrate Touch Screen

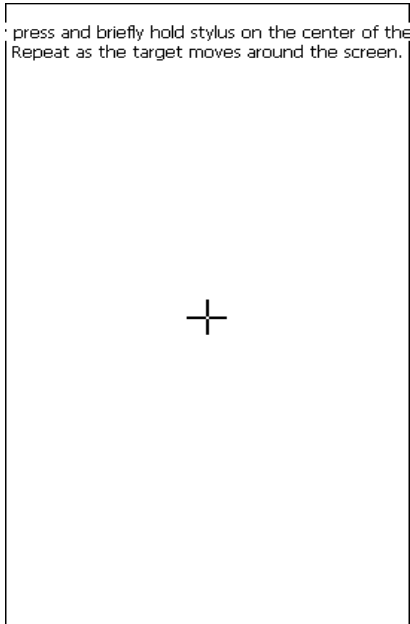

The initialization screen will skip to the calibration screen in 12 seconds, as shown on the left. Click the "+" on the screen accurately and orderly. After it changes, you complete a calibration. If you don't want to calibrate, press the power key to skip the calibration screen.

Note: If you don't click "+" accurately, the "+" will be present on the screen again and again, until the calibration completes.

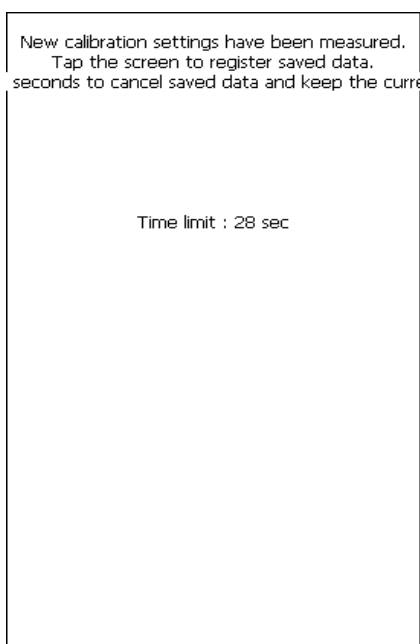

The screen as shown on the left will appear after the touch screen calibration successes. You can click to enter the system interface by manual, or wait for 30 seconds to enter automatically.

2.5.3 Taskbar

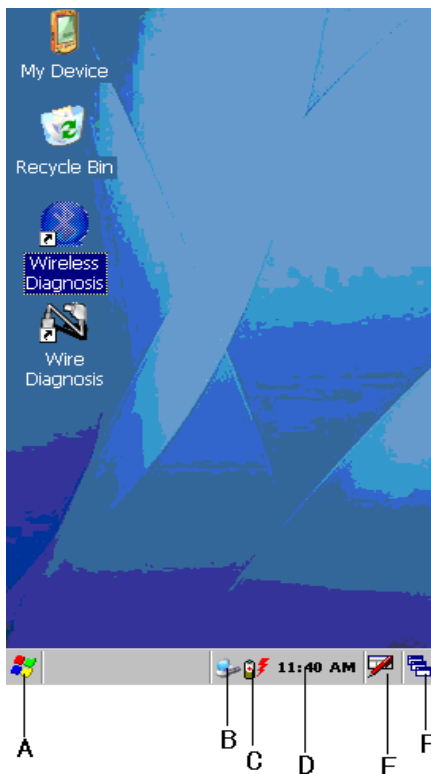

There is a taskbar at the bottom of X-431Diagun system desktop shown on the left.

A Start Button: the same method as Windows98/XP.

B Network Connection Icon: displays network connection state. (when connected to PC)

C Battery Icon: indicates the battery state. (for details to see 2.6)

D Time: sets the time, data and time zone by double-clicking here with the touch kit.

E Soft Keyboard Icon: displays and hides the soft keyboard, when the soft keyboard is activated, there are two types of input method to select, they are: 1. Manual; 2. English.

F Switch Icon: displays the desktop, and switches among the interfaces.

2.6 Charge

There are three methods to charge X-431Diagun: one is to use the charger (for details to see 2.3, No.6 in Diagram 2-2), the second is to charge through an external power (DLC) and the last is to charge when connecting to PC through the USB port.

2.6.1 Description of the Power Indicator State

Charge through the charger

Charge it under conditions of power off, power on and stand-by mode. The power indicator always come on when charging and goes out when the battery is full.

Note: It is better to charge in stand-by mode for charging saturation. (How to standby: click the start menu "  " to find "Suspend", or press the power key of the main unit. And press again to return the normal state.)

Charge through DLC

Charge it under conditions of power off, power on and stand-by mode. The power indicator always come on when charging and goes out when the battery is full.

Charge by PC

Charge it by connecting to PC through the USB port.

2.6.2 Description of the Battery State

1. Power on under conditions of being connected with charger or an external power supply. The icon "  " will appear in the taskbar. It indicates charging

in the power management interface, as shown below:

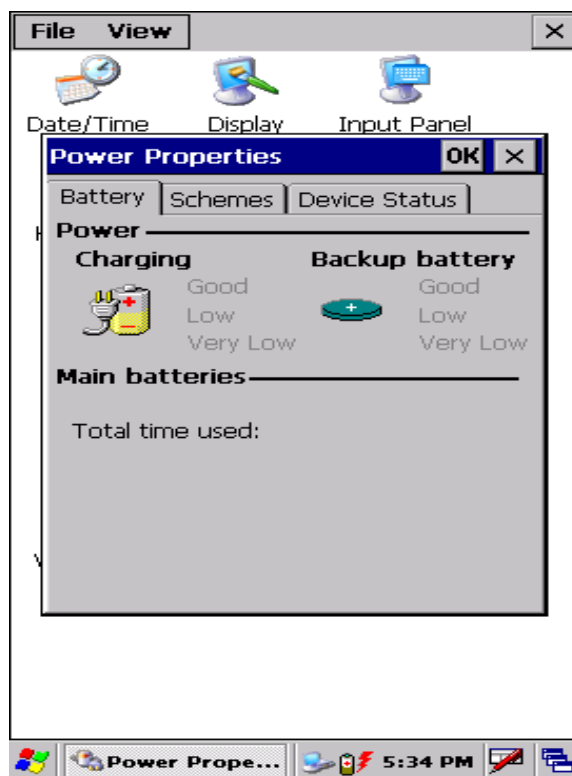

Note: Click the start button "  " in the bottom left-hand corner of the screen, and click "control panel". With a new window pops up, double click "Power", and the power management interface appears. You can also double click the battery indication icon to view the power management interface, as shown above.

2. When using this equipment without connecting an external power supply, if the battery is more than 40%, no icon appears in the taskbar, and the actual battery will be shown.

3. When using this equipment without connecting an external power supply, if the battery is less than 40% and more than 10%, the icon "  " appears in the taskbar. It shows the actual battery in the power management interface.

4. When using this equipment without connecting an external power supply,

if the battery is less than 10%, the icon "" appears and indicates the battery is too low.

3 Use X-431Diagun to Diagnose vehicle

3.1 Automotive Diagnosis Preparation and Connection

3.1.1 X-431Diagun preparations

1. General Test Condition

- Ignition on.
- The vehicle battery voltage is 11-14V or 18-30V, and the working voltage of X-431Diagun is 12V or 24V.
- Throttle is closed, that is to say the throttle closed position switch is on.
- Ignition timing and idle should be in the valid range, and the water temperature and transmission oil temperature must reach the normal operation temperature (water temperature is 90 – 110°C and transmission oil temperature is 50 – 80°C) .

2. Test Connection Selection

X-431Diagun is armed with an OBD II 16PIN connector. Select the corresponding connector (optional) when testing the vehicle with non-OBD II 16PIN DLC.

3.1.2 TF Card Installation

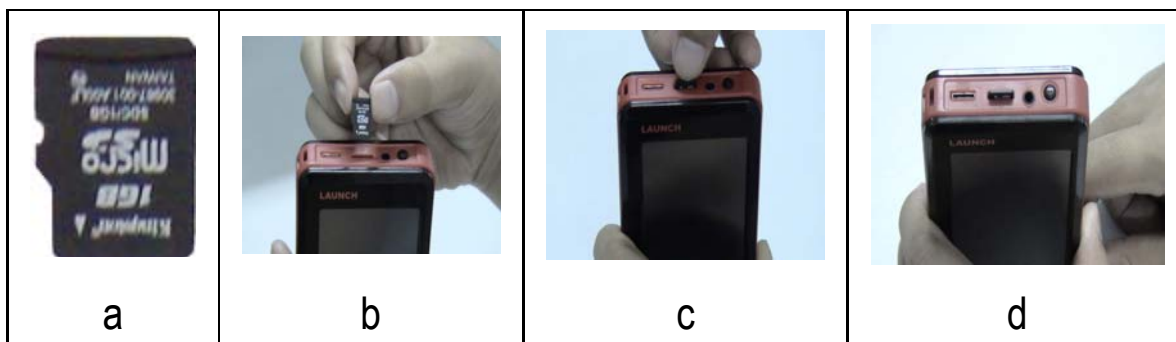

Figure 3-1 TF Card Installation

Installation Procedure:

- 1) Take out the TF card from the box, as shown in Figure 3-1a.
- 2) Insert the TF card into the X-431Diagun TF card slot perpendicularly. Make sure that the printed "micro" is upward and in the right place, as shown in Figure 3-1b, 3-2c and 3-3d.

Note: You can hear a clicking sound when you insert the TF card in the right place. If you want to take it out, press the TF card slightly, and it will pop up automatically with a clicking sound.

3.1.3 Connect X-431Diagun

X-431Diagun can also diagnose two cars at the same time (test with the diagnosis connectors by wire/wireless connection, one is OEM and the other is optional), so wire and wireless connections are the two different methods.

Wire Connection Procedure of X-431Diagun:

- Insert the TF card into the slot;
- Connect one end (20PIN Male) of the X-431Diagun main unit diagnosis cable and X-431Diagun main unit diagnosis interface;
- Connect the other end (USB terminal) of X-431Diagun main unit diagnosis cable and one end (USB port) of selected X-431Diagnun connector.
- Find the vehicle DLC;
- Connect the X-431Diagun diagnosis connector and the vehicle DLC.

Wireless Connection Procedure of X-431Diagun

- ◆ Insert the TF card into the slot;
- ◆ Find the vehicle DLC;
- ◆ Connect the X-431Diagun diagnosis connector and the vehicle DLC.

Note: The Bluetooth indicator lamp on the X-431Diagun diagnosis connector goes out when actuating wire diagnosis.

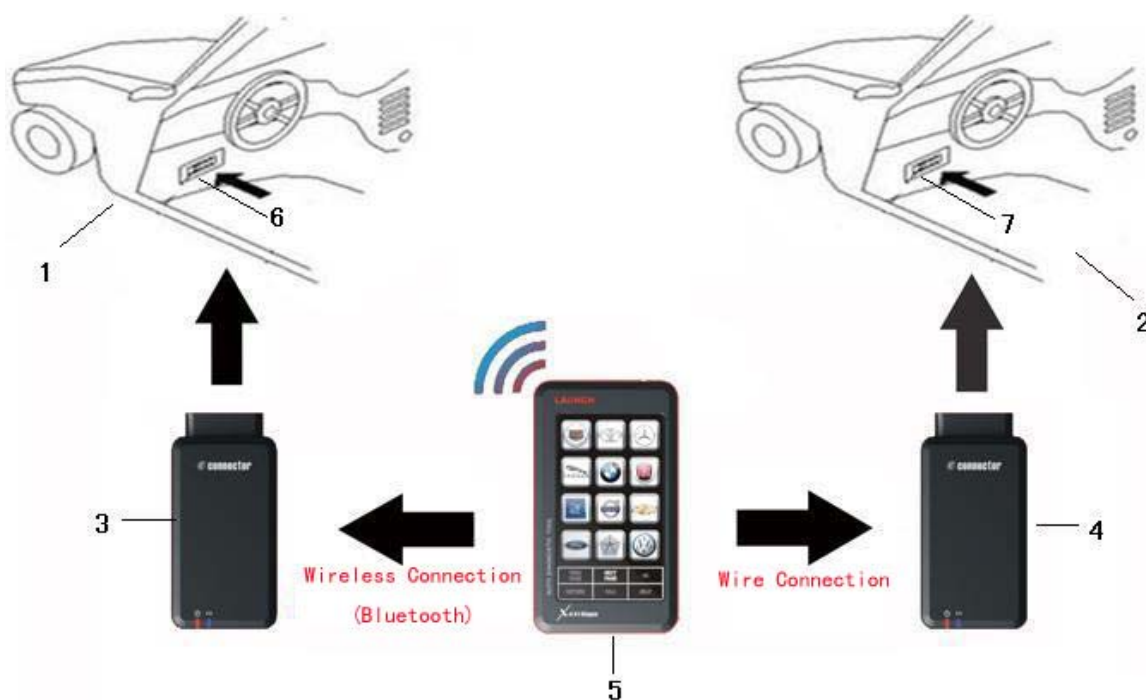

Figure 3-2 wire/wireless connection

1 and 2 Diagnostic Target 3 and 4 X-431Diagun Diagnostic connector 5. X-431Diagun main unit 6 and 7 DLC

Note: If the DLC of the tested vehicle is low battery or its terminal is damaged, you can get another power through any method below.

1. Cigar lighter (Optional)
2. Pull out the cigar lighter. Insert one end of the cigar lighter cable into the cigar lighter hole and connect the other end to the power of the

X-431Diagun non-16PIN connector (Optional).

3. Trough the double-clamps power cable (Optional): Connect the red-crocodile clamp of the double-clamps power cable to the battery positive, and the black-crocodile clamp to the battery negative. Connect the other end to the power of the X-431Diagun non-16PIN connector (Optional).

If the X-431Diagun is low battery, do one of the following:

1. Provide power through DLC: connect the main unit and the diagnosis connector by wire connection.
2. Provide power through the charger: insert one terminal (20PIN Male) of the charger into the diagnosis port of X-431Diagun main unit and connect the other terminal with 100-240V AC.

3.2 Begin to Diagnose Vehicle

The makers, models and systems tested by X-431Diagun update every day. Please visit <http://www.x431.com> to learn more information and download the diagnosis program of the latest version.

3.2.1 Diagnostic Program



After connections (for details to see 3.1.3), Power on and the calibration screen appears (see 2.5.2), and after that, with the Wince screen displayed, double click the icon "Wireless Diagnosis" on the desktop to operate X-431Diagun, as shown on the left.



The maker screen will appear as shown on the left.

Button Descriptions:

[RETURN]: returns the previous interface.

[PREVPAGE]: shows the previous page. This button is invalid if there is only one page or the first page currently.

[NEFTPAGE]: shows the next page. This button is invalid if there is only one page or the last page currently.

[CALL]: view the vehicle management record. (the stored datastream and oscillograph)

[SET]: select the language.

Here we will take the wireless connection and Benz demo program for example to introduce how to actuate automotive diagnosis.

Click [SET] in the bottom right-hand corner of the screen shown above. Select English and click [OK].

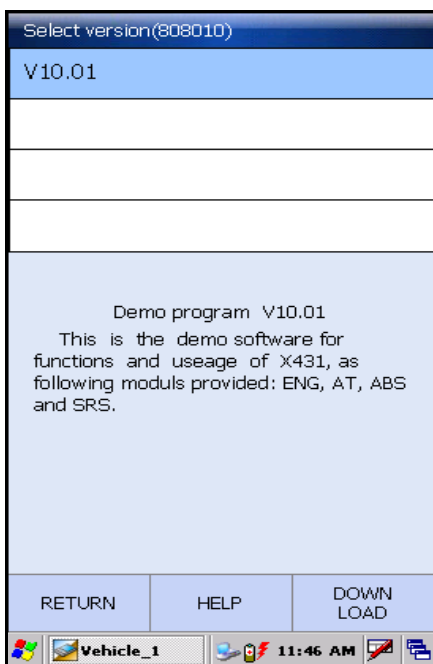

Click the Benz logo from the maker menu. With Benz demo diagnosis program version screen displayed, select the version you need.

Note: The operations of other makers and models are the same as Benz. For details to see relevant system operation introduction, and here we only take Benz demo program for example.

Button Descriptions:

[RETURN]: returns the previous interface.

[HELP]: view the help information

[OK]: continues to test.

3.3 How to Diagnose

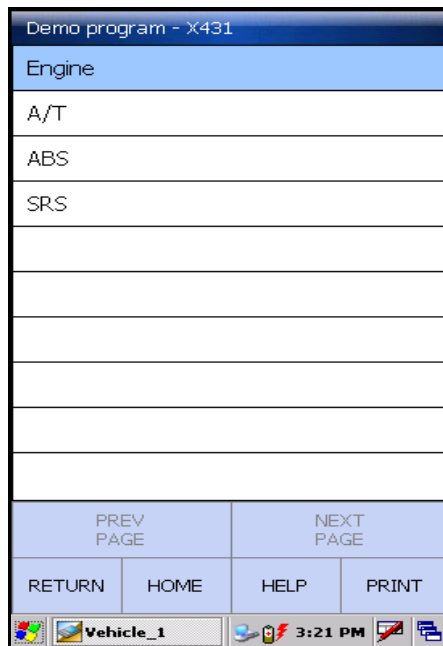

Select the version "V10.01", and click [OK] to enter the diagnosis screen, as shown on the left.

Note: The diagnosis screen of different makers contains the tested models, systems, diagnosis connector and DLC location. The operations are similar.

Button Descriptions:

[RETURN]: returns the previous interface.

[HOME]: resume the program.

[HELP]: shows the help information.

[PRINT]: prints the test result.

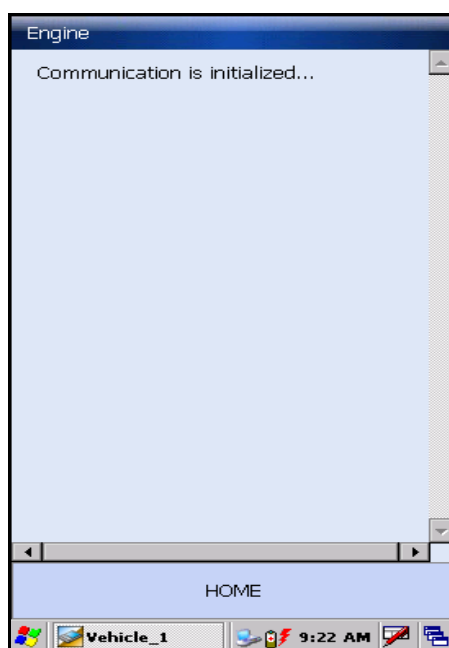

Click [Engine] on the tested system menu.

Note: The test method for different systems is similar. Here we take [Engine] for example.

After clicking, "Communication is Initialized" screen will appear as shown on the left.

Print Fault Code

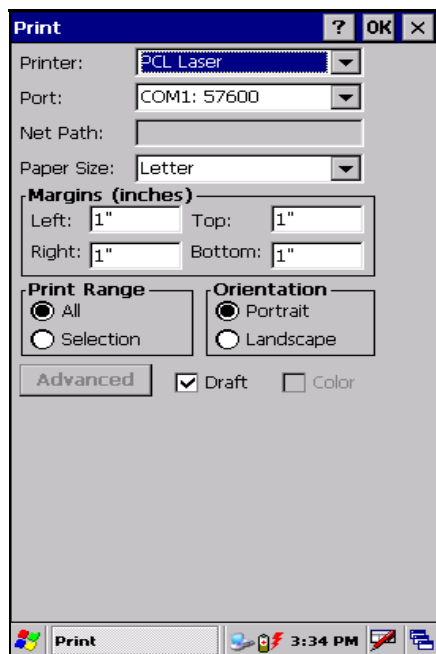

Printer connection: connect one end (20PIN Male) of the printer cable to X-431Diagun, and the other end (USB connector) to the USB port of the printer.

After connection, click [PRINT], as shown on the left.

Button Description:

[OK]: returns the function menu of the diagnostic system.

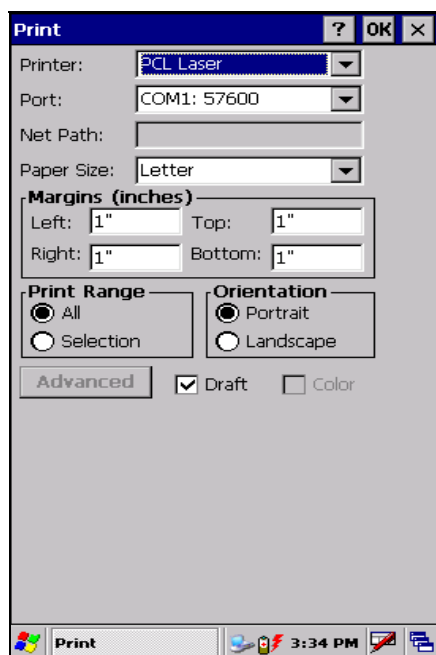

With the printer screen displayed, select the printer type and the terminal number, and then click [OK] to print the fault code information, as shown on the left.

Note: Select the correct printer type and terminal number to match the printer due to different printers used by users.

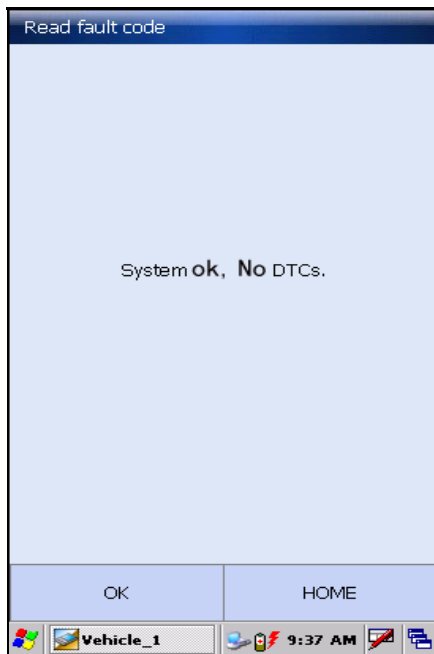

If there is no fault code from the tested system, the screen is as shown on the left.

Button Description:

[OK]: returns the function menu of the diagnostic system.

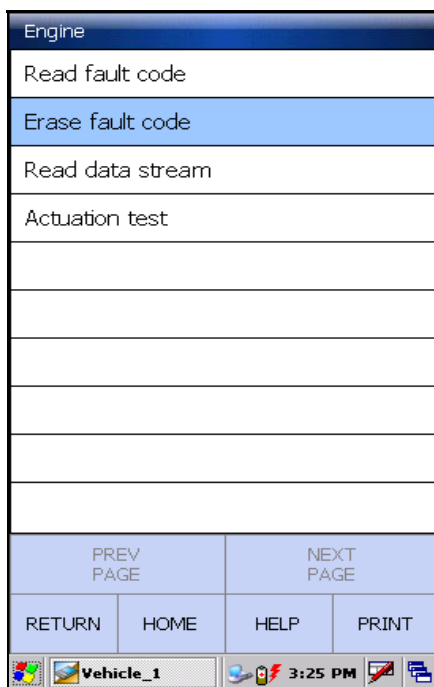

3.3.2 Erase Fault Code

Click [Erase fault code] on the function menu to erase the fault code, as shown on the left.

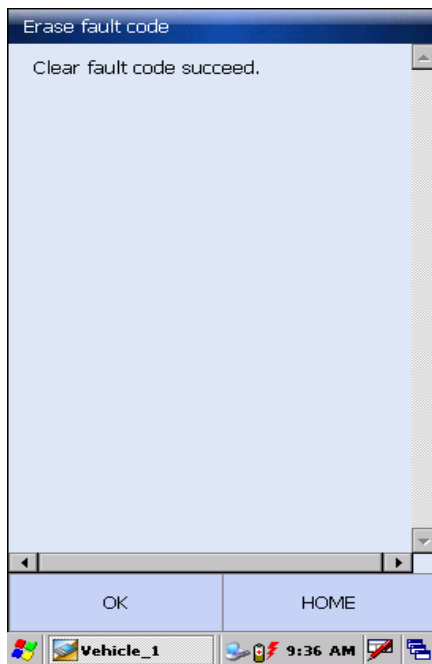

After clicking, erasing fault code succeeded. "No fault code" will appear on the screen if all the fault codes were erased or no fault code from the tested system.

Button Description:

[OK]: returns the function menu of the diagnostic system.

3.3.3 Read Datastream

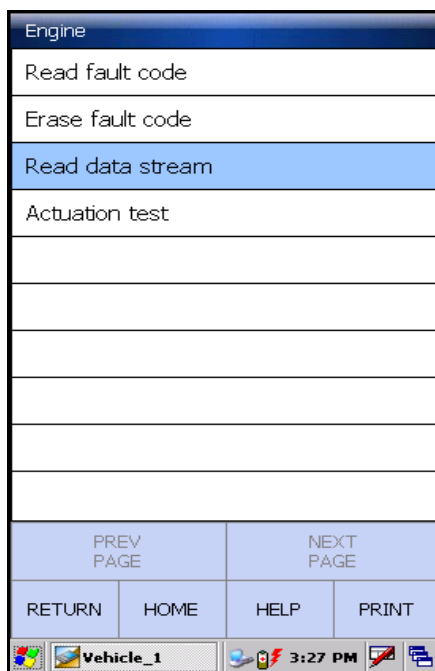

Click [Read datastream] on the function menu to read the datastream from ECU, as shown on the left.

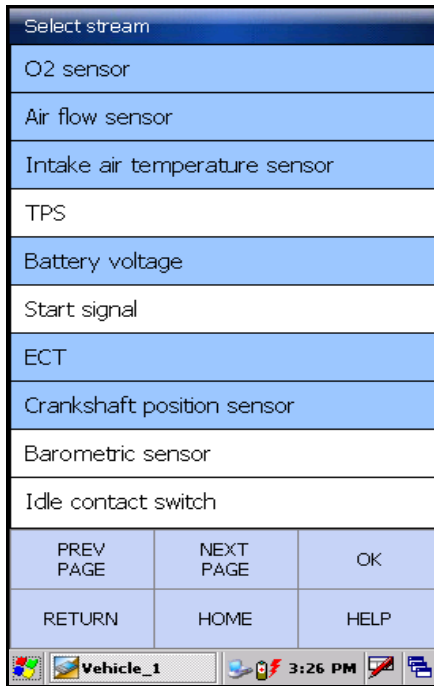

Select the datastream items displayed with blue, as shown on the left.

Button Descriptions:

[NEXTPAGE]: displays the datastream item on the next page.

[OK]: displays the dynamic data of the selected datastream.

[RETURN]: returns the previous interface.

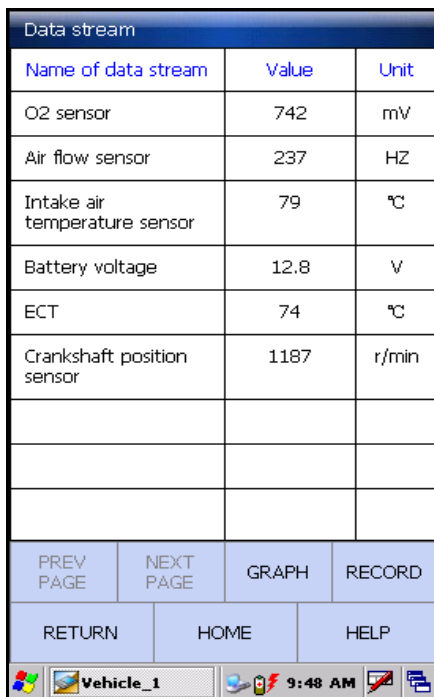

Click [OK], this screen contains the dynamic data of the selected datastream item, as shown on the left. Click [RECORD] to store the dynamic datastream of the current time segment.

Button Descriptions:

[GRAPH]: displays the waveform of a single datastream item.

[RECORD]: records the current dynamic datastream.

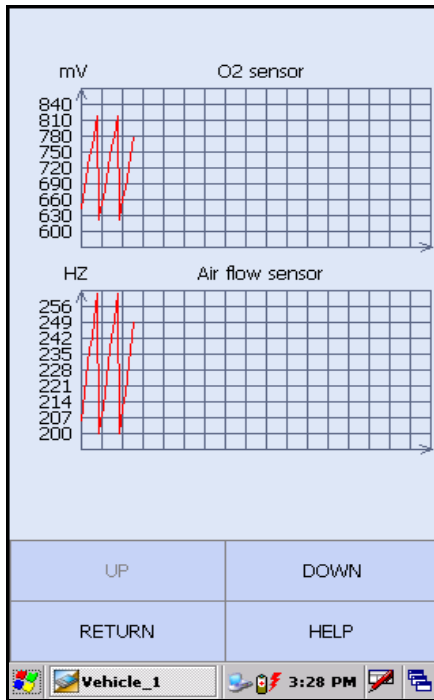

With the datastream screen displayed, click to select the datastream. And then click [GRAPH] to view the datastream oscillograph (not more than two) as shown on the left.

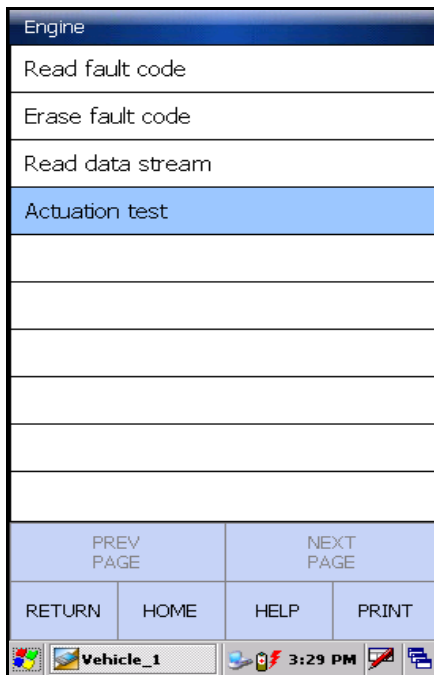

3.3.4 Actuation Test

Check the system parameter for normality.

Click [Actuation test] on the function menu, as shown on the left.

Note: Here take [Cylinder 1# injector] for example.

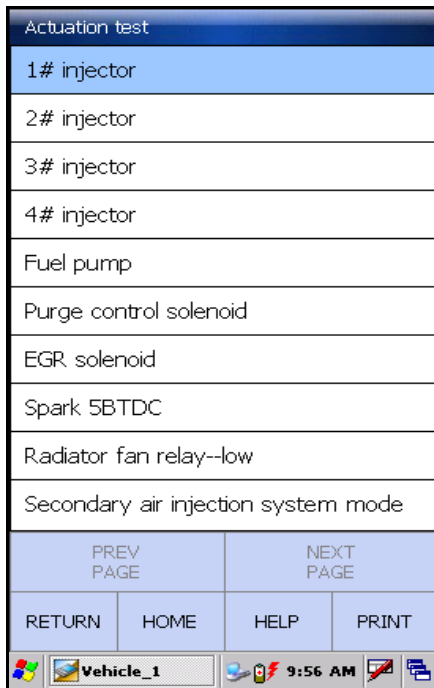

Click [Cylinder 1# injector] as shown on the left.

Note: Click [Cylinder 1# injector] to check it for normal operation.

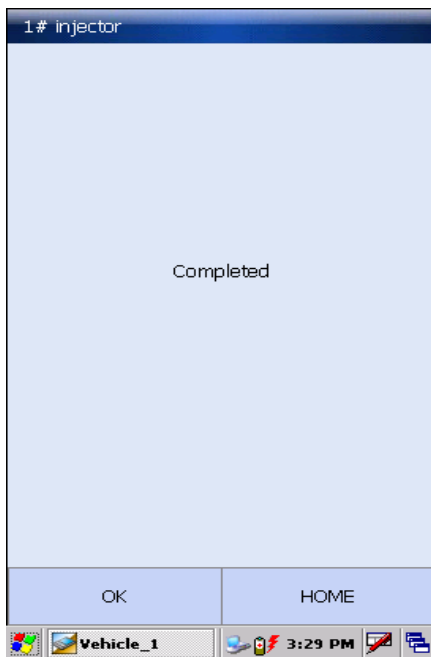

Set succeeded, as shown on the left.

Note: The relevant fault will occur with set failure or abnormal operation of [Cylinder 1# injector].

3.3.5 Driving Record Administration



View the stored datastream and oscillograph.

With the maker screen displayed , click [CALL], as shown on the left.

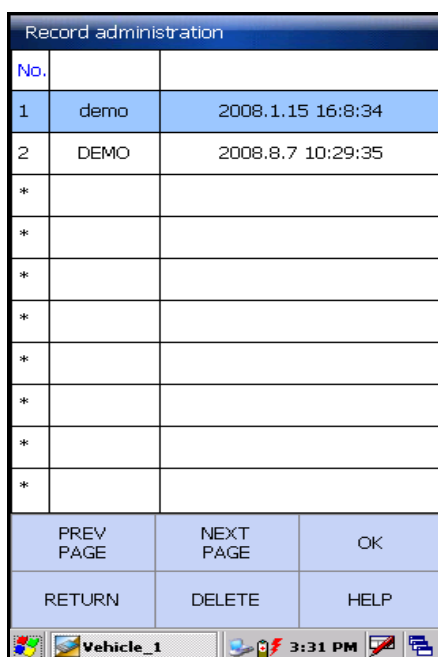

After clicking, the datastream information documents in each time segment appear for different makers, as shown on the left.

Click [OK] to view the recorded datastream for the time segment and model you selected.

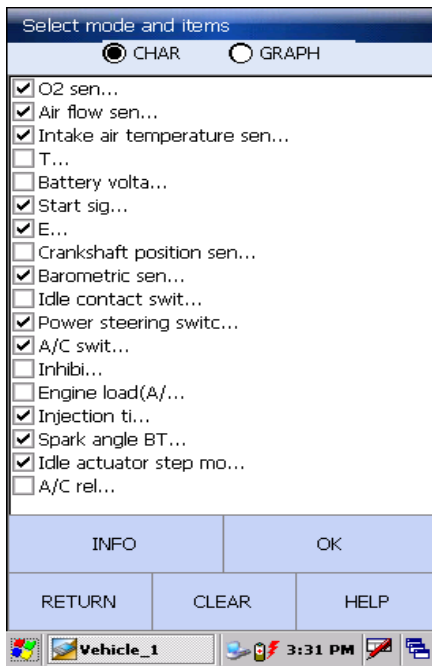

Select the datastream to include in the Select mode and item. Select "CHAR" or "GRAPH" as you want, as shown on the left.

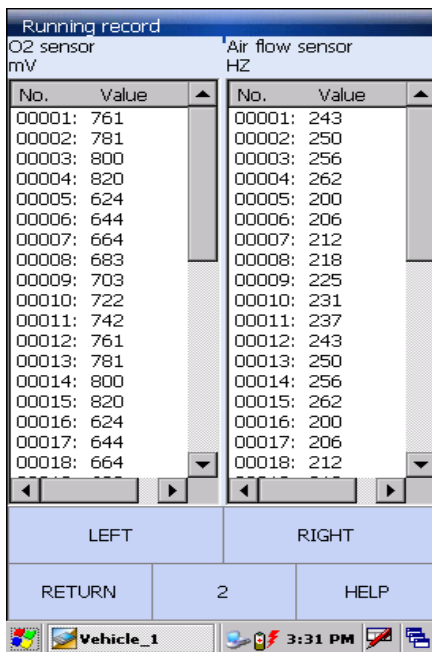

After selections, click [OK]. The recorded dynamic data will appear again, as shown on the left

Button Descriptions:

[Left] : shows the hidden datastream on the left.

[Right] : shows the hidden datastream on the right.

3.5 How to diagnose two cars at the same time



Compare and analyze the datastream of two cars by "Wire connection" and "Wireless connection" with X-431Diagun.

One is connected by "Wire connection" and the other is connected by "Wireless connection". (for details to see 3.1.3)

3.5.1 Read the datastream of the first car



After connecting the first car by wireless connection, double click the icon "Wireless Diagnosis".

The maker screen will appear, as shown on the left.

Select Benz and click "OK".

Note:

"Vehicle_1" in the taskbar means the first car connected by wireless connection.

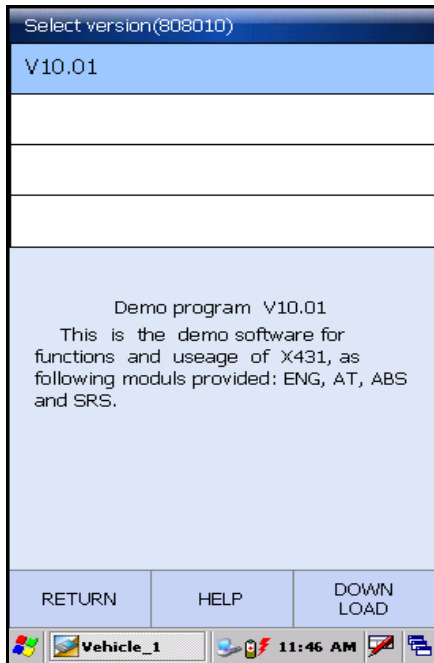

With the "Diagnostic program version" screen displayed, select the version "10.01" and click [OK].

Note: The operations of other makers and models are the same as Benz. For details to see relevant system operation introduction, and here we only take Benz demo program for example.

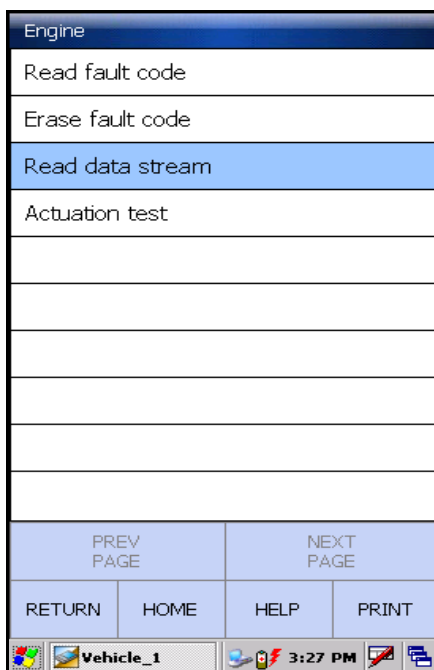

Click [Read datastream] on the function menu to read the datastream from ECU, as shown on the left.

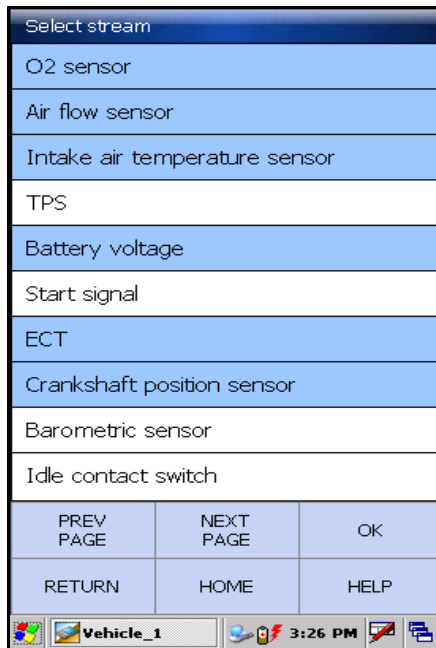

Click the datastream you want, displayed with blue, as shown on the left.

Data stream		
Name of data stream	Value	Unit
O2 sensor	742	mV
Air flow sensor	237	HZ
Intake air temperature sensor	79	°C
Battery voltage	12.8	V
ECT	74	°C
Crankshaft position sensor	1187	r/min
PREV PAGE	NEXT PAGE	GRAPH RECORD
RETURN	HOME	HELP

The screenshot also shows a taskbar with 'Vehicle_1' and the time '9:48 AM'.

Click [OK] and the dynamic data of the selected datastream items will appear on the screen, as shown on the left. Until now, reading the datastream of the first car has completed.

3.5.2 Read the datastream of the sencod car

Click the "Switch" icon in the bottom right-hand corner of the screen to switch to desktop, as shown on the left.

Data stream		
Name of data stream	Value	Unit
O2 sensor	742	mV
Air flow sensor	237	HZ
Intake air temperature sensor	79	°C
Battery voltage	12.8	V
ECT	74	°C
Crankshaft position sensor	1187	r/min
PREV PAGE	NEXT PAGE	GRAPH
		RECORD
RETURN	HOME	HELP
		

As shown on the left after clicking.





Connect the second car by wire connection and then double click "Wire Diagnosis" on the desktop.

The maker screen will appear on the screen, as shown on the left.

Select as the procedure order as reading the datastream of the first car. (for details to see 3.5.1)

Note:

- Do select a car with the same maker or version.
- The "Vehicle_2" in the taskbar mesns to diagnose the second car by wire connection.

Data stream		
Name of data stream	Value	Unit
O2 sensor	703	mV
Air flow sensor	225	HZ
Intake air temperature sensor	81	°C
Battery voltage	12.6	V
ECT	76	°C
Crankshaft position sensor	1125	r/min
PREV PAGE	NEXT PAGE	GRAPH RECORD
RETURN	HOME	HELP

The dynamic data of the second car datastream item will appear on the screen, as shown on the left.

3.5.3 Comparison and Analysis of Datastream

Data stream		
Name of data stream	Value	Unit
O2 sensor	722	mV
Air flow sensor	231	HZ
Intake air temperature sensor	80	°C
Battery voltage	12.7	V
ECT	75	°C
Crankshaft position sensor	1156	r/min
PREV PAGE	NEXT PAGE	GRAPH RECORD
RETURN	HOME	Vehicle_1 Desktop

This function is to compare and analyze the datastream from a faulty car with that from a good. The two cars must be from the same model.

Click the "Switch" icon in the bottom right-hand corner of the screen to view the datastream information of two cars, in order to realize the comparison and analysis of datastream, as shown on the left.

Data stream		
Name of data stream	Value	Unit
O2 sensor	742	mV
Air flow sensor	237	HZ
Intake air temperature sensor	79	°C
Battery voltage	12.8	V
ECT	74	°C
Crankshaft position sensor	1187	r/min
PREV PAGE	NEXT PAGE	GRAPH RECORD
RETURN	HOME	HELP

The datastream information of the first car will appear on the screen after switching, as shown on the left.

4 Update of Diagnostic Software

4.1 User Registration

The Internet update function of X-431Diagun provides user with a convenient and quick way to download the software from www.x431.com for update.

First visit www.x431.com.

The homepage will appear as shown below.



Click [Registration] to view the website terms of service.

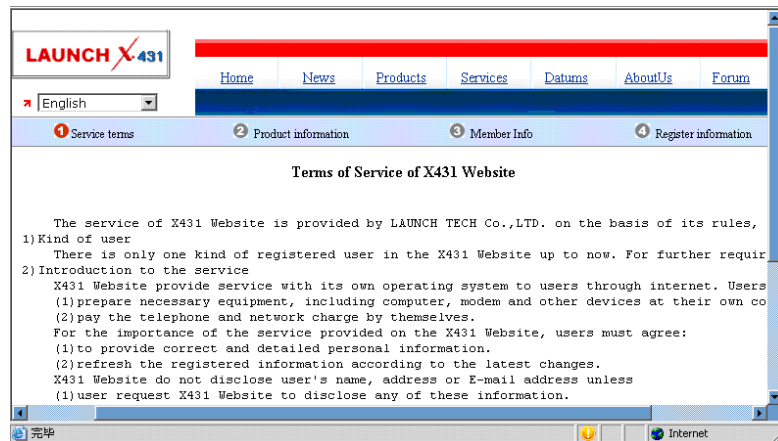

Note:

When the member purchases one or more products after registration, he should log onto the member area, and then click "product control" to register the newly purchased product. Refer to the section "Member login".

The terms of service are shown on the screen. After reading and fully understand it, click "I accept" button to enter the interface as shown in the figure below.

Fill in Production Information

A screenshot of the LAUNCH X-431 website showing the "Product information" registration step. The page has a navigation bar with "Home", "News", "Products", "Services", "Datums", "AboutUs", and "Forum". Below the navigation bar, there are four numbered steps: 1 Service terms, 2 Product information (highlighted), 3 Member Info, and 4 Register information. The main content area contains three input fields:

Product serial No.

Register password

Vendor code

The browser's address bar shows "Internet".

Fill in the serial No. of X-431Diagun. The registration No. is in an envelope delivered with the product (the number must be kept confidential). The dealer code is attached on the last page of the user's manual. After the

information is filled, click "Next step".

Note:

- 1) *When a product is sold, the dealer will log onto www.x431.com and enter the dealer code in the "Dealer administration" area so that the user can do effective registration later. User should contact the dealer if registration can not be done effectively.*
- 2) *If the filled serial No. or registration No. is invalid, the screen will display the message as shown in Figure below. Click "OK" button to return to the previous interface to re-fill the correct numbers.*

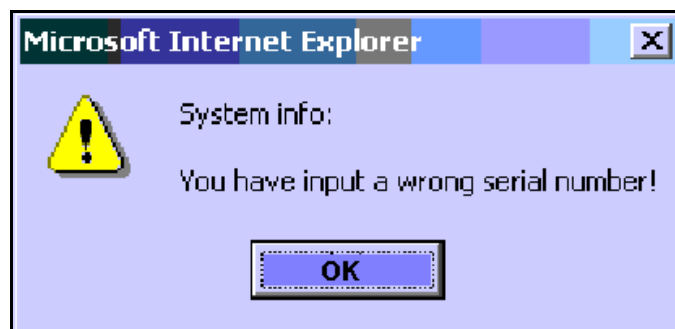

Fill in User Information

A screenshot of the LAUNCH X431 website registration form. The page has a red header with the LAUNCH X431 logo and navigation links: Home, News, Products, Services, Datasets, About Us, and Forum. Below the header is a language dropdown menu set to "English". The main content area has four tabs: 1 Service terms, 2 Product information, 3 Member Info (which is selected), and 4 Register information. Under the "Member Info" tab, there are two sections: "Logon information" with fields for Username, Password, and Confirm password; and "Company information" with fields for Dealer name, Telephone, Fax, Postcode, Address, Country, Province, and City.

After information is filled in the interface as shown above (The red textbox must be filled. After registration, we will send the confidential information to your registered e-mail, so please make sure that your e-mail is valid.), click "Next step", and then the screen will display the interface as shown below.

Click "OK" then the registration is completed.

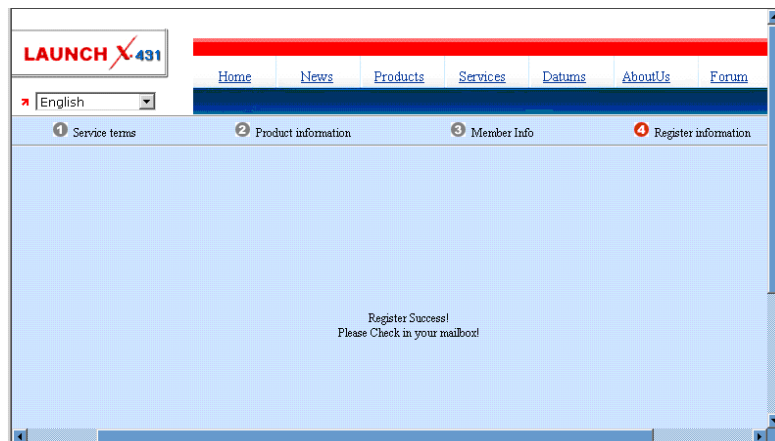

4.2 Member Login

The user becomes the registered member after registration. Member can log in the website by filling username, password and user type in the interface as shown in the figure below.



After log successfully, the screen will display the interface as shown in the

figure below.

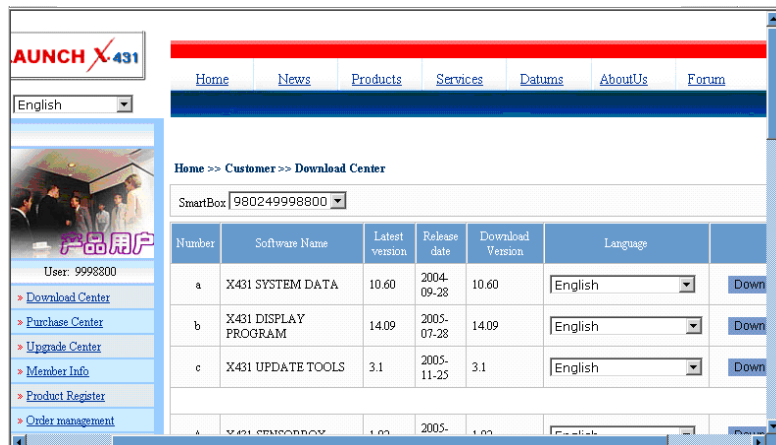

[Download Center]: Refer to "software download".

[Purchase Center] & [Update center]: Refer to "software purchase and update"

[Member Information]: Display and renew the current member information.

[Product Registration]: Register newly purchased product.

[Order Information]: Check or cancel the unpaid order.

[Renew Password]: After entering the right old password, then can renew the password.

[Awarded for complaint] If users meet some trouble during the operation, he can feedback to LAUNCH. Effective complaint will be awarded by LAUNCH

[Logout]: Users exit the registration.

4.3 Software Download

After log successfully, the screen will enter the [download center] interface.

Note:

1. *Software update of free charge will be provided by LAUNCH for one year. The free period is from the registration date on the website, not the purchase date. That is, during one year*

after the registration, users can free download the corresponding software.

- 2. If there is not the latest version in the download center, users can buy the version in the purchase center or in the update center. In the purchase center, users can buy the software that doesn't install in the download center. In the update center, users can buy the software that is beyond the free download period. After purchase successfully, the purchased software will be automatically added to the download center list.*

Update Tool Download

Before update, users must download the update tools. On the drop-down menu, users select the language then click [download]. The screen will display the interface as shown in the figure below.

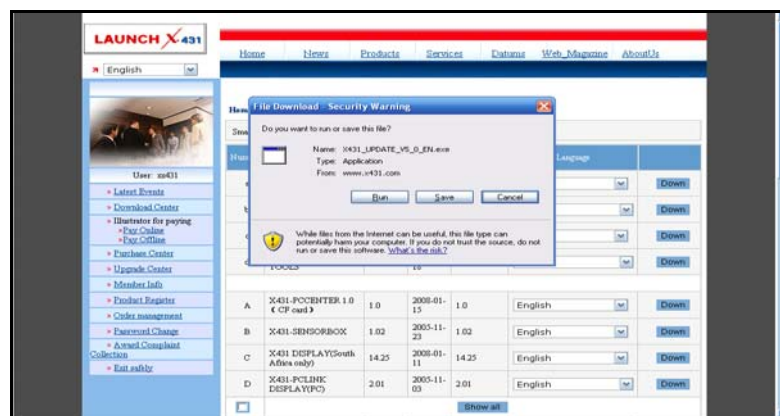

Display Program Download

When downloading the diagnostic program, users can also download the display program. On the drop-down menu, users select the language then

click [down].Click [save] on the pop-up menu to put the program into the[X-431 update].

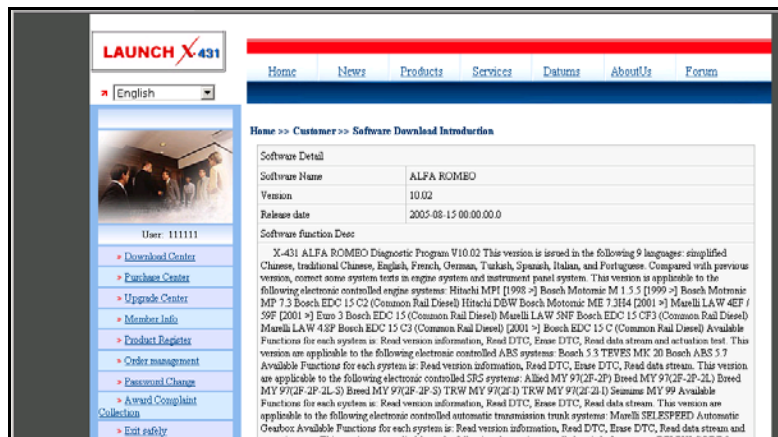

Diagnostic Program Download

On the drop-down menu, select the language and the version (The default version is the latest version). Click [down] icon, then click [save] on the pop-up menu to save the file. Click [view] to learn the detailed information of the version. Users can download the diagnostic program into the [X-431Diagun update]. Up to now, the software that is for update is downloaded completely.

4.4 Software Update

Two methods: one is direct update (connect X-431Diagun main unit to PC) and the other is indirect update (connect the card reader with TF card to PC)

4.4.1 Direct Update

X-431Diagun main unit connection and drive program installation

Necessary hardware:

1. A computer that can access the internet.
2. A X-431Diagun main unit and a USB cable.

Necessary software:

ActiveSync, tested model software and update tool (download from www.x431.com)

Connection

The connection between the X-431Diagun main unit and PC are shown below:

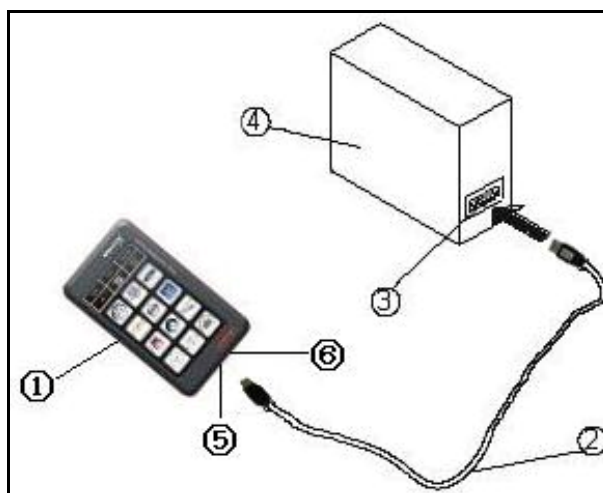

- ①-X-431Diagun main unit ②-USB cable ③-USB port ④-PC
⑤-TF card ⑥-USB port

- A. Insert the TF card into TF card slot of X-431Diagun main unit (for details to see 3.1.2).
- B. Connect one end of the USB cable② to the X-431Diagun main unit①, and the other end to the USB port of the computer.

ActiveSync Drive Installation

You must install the ActiveSync drive program (You can download it from www.x431.com) when you perform the direct update, otherwise the computer can not identify the X-431Diagun main unit. (Operating system: Windows Me/2000/XP, Mac OS 9.x/Mac OS X or Linux 2.4.x)

ActiveSync Installation Procedure in Windows XP:

Startup Windows XP:

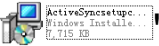

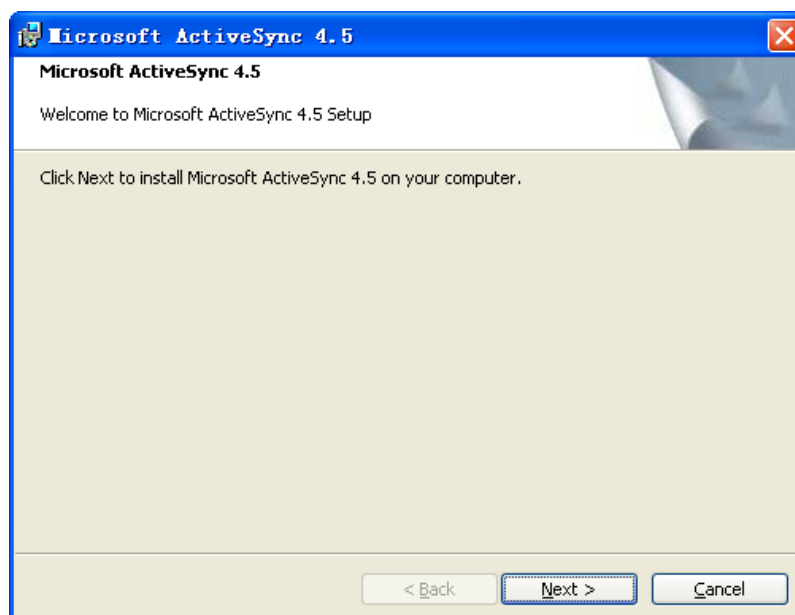
Connect the X-431Diagun main unit to the USB port of the computer through a USB cable. Open the folder which stores the program, and double click the icon "  " to install it. Now the system is preparing for the installation, as shown below:

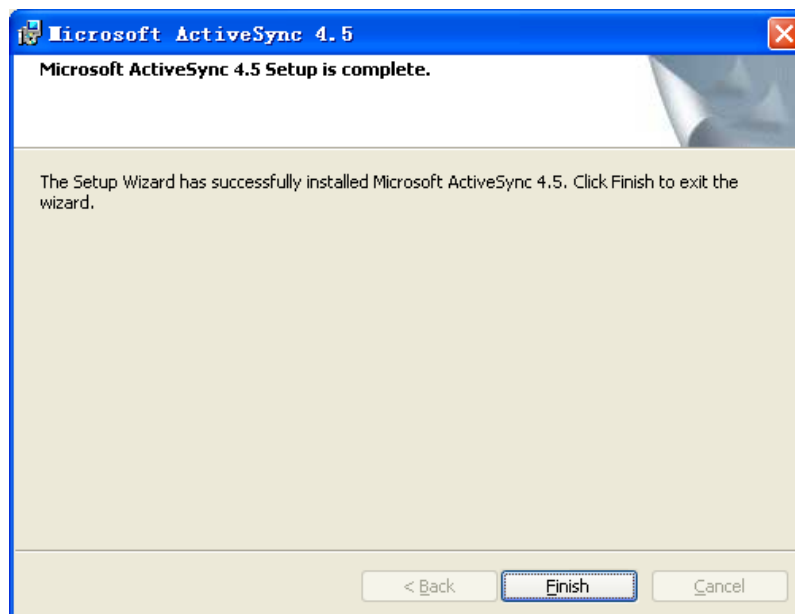

Install according to the Wizard, click "Next".



The Installation is completed and click "Finish", as shown above.

Note: After the connection between the X-431Diagun main unit and the computer, the ActiveSync icon in the taskbar is "  ", but if the connection is poor, the icon is "  ".

Begin to Update Software

Open the [Software Update] folder, double click the icon "  ", and install the X-431Diagun update tool according to the Wizard.

After the installation, the update icon of the X-431Diagun will appear on the desktop.

Double click the update icon of X-431Diagun on the desktop to run the update tool. This program will automatically check the update file downloaded by the user, including the files of diagnostic program and display program, as shown below.

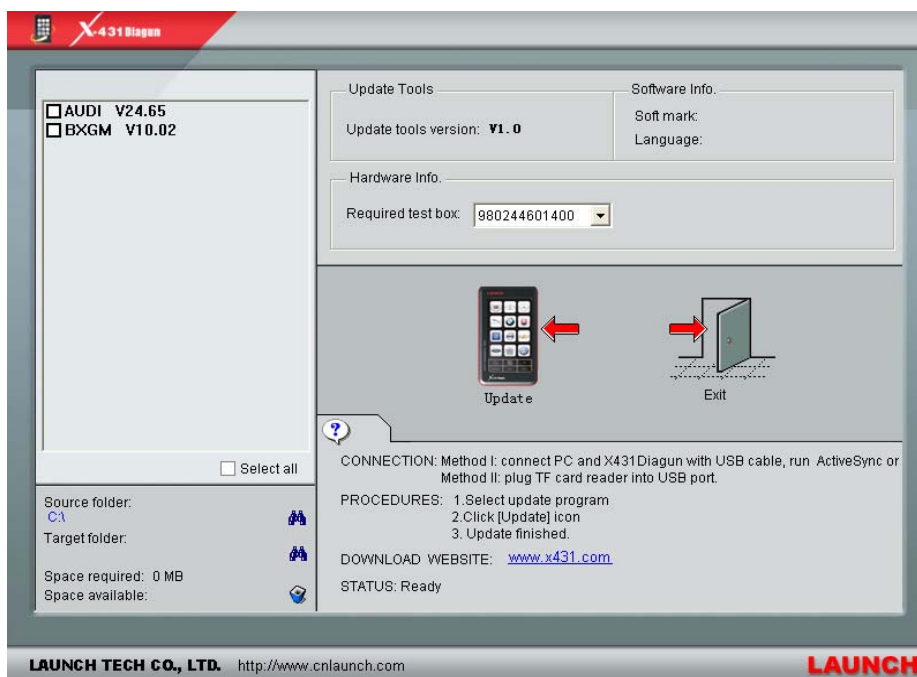

Select the update program version on the right, and then click [UPDATE]. After updating, the indication will pop up for updating completion. If the update program doesn't exist on the right, find the update program by clicking the icon "  ".

You can click the corresponding icon "  " of G disc to view the files stored in the TF card and cancel some old software versions if necessary for the TF card with enough capacity.

Click [EXIT] to exit.

4.4.2 Indirect Update

Connection between card reader with TF card and PC and drive program installation

Necessary hardware:

- 1) A computer that can access the internet.
- 2) A TF card reader of X-431Diagun and a TF card to be updated.

Necessary software:

Tested model software and update tool (download from www.x431.com)

Connection

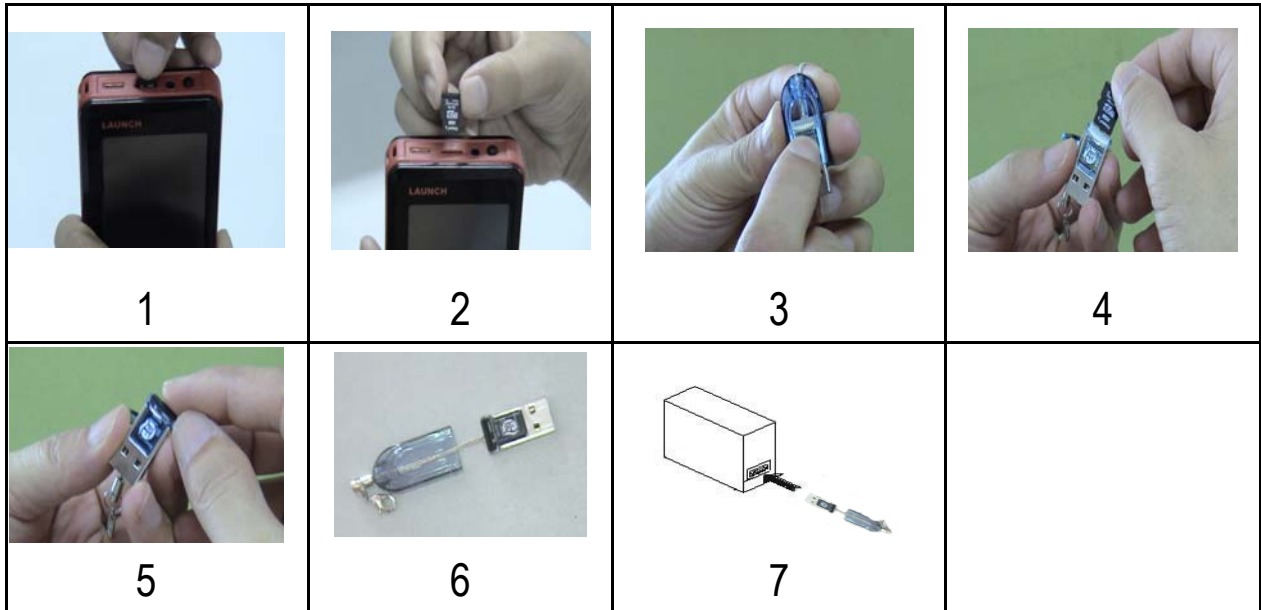

Steps:

- a) Eject the TF card from the X-431Diagun main unit (press the TF card slightly and it will pop up automatically, as shown in Figure 1 and Figure 2);
- b) Insert the TF card into the card reader (as shown in Figure 3, the side printed with words is upward, and insert the TF card into the card reader perpendicularly, as shown in Figure 4, Figure 5 and Figure 6);
- c) Connect the card reader to the USB port of the computer.

TF Card Reader Drive Program Installation

You don't need to install the drive program if the operating system of your computer is Windows Me/2000/XP, Mac OS 9.x/Mac OS X or Linux 2.4.x, but if the operating system is Windows98, you must install the drive program. You can download the installation software from www.x431.com and install it according to the Installation Wizard.

If the card reader is installed successfully, this icon " " will appear in the "My computer".

Note: The update method of indirect update is the same as that of direct update, for details to see 4.4.1.

We suggest you to use the second method.

Interruption may be caused by the following reasons during the update process. Please try again after solving the problem.

- 1) TF card reader is poor connected to the computer or the drive program of the TF card is installed incorrectly.
- 2) TF capacity is not enough.
- 3) Other reasons.

4.5 Software Purchase and Update

If users can't find the software that he needed, at this time users should buy the software in the purchase center. Log on the www.x431.com then enter the interface as shown in the figure below.

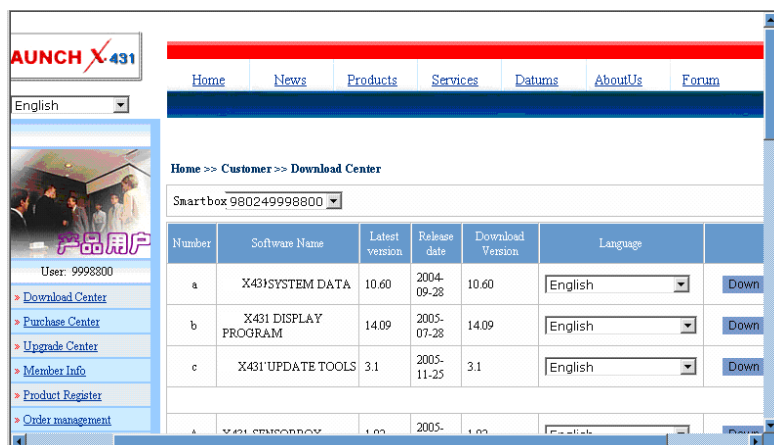

Click [purchase center] to choose the serial number, and then tick in front of the serial number.

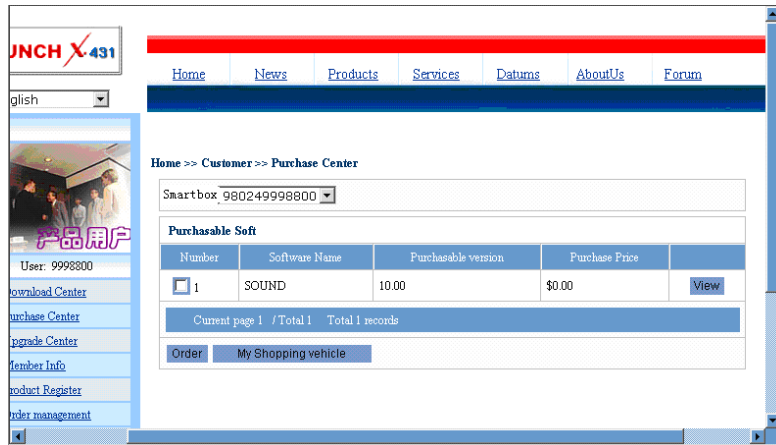

Take the Transporter & V Class for example. Click the [view] that is in the same line with the Transporter & V Class. The screen will display the concrete information about the Transporter & V Class diagnostic software.

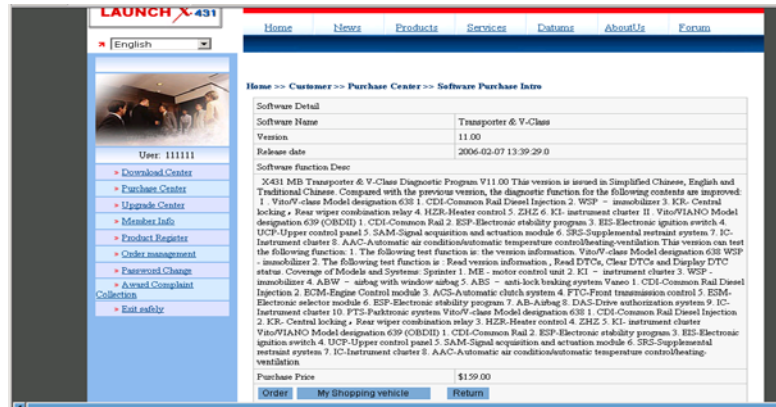

Click [order] to add the selected software to shopping cart.



Click [pay] to buy the software. The bought software will be automatically added to the user's download center.

Click [clear] to clear all the software in the shopping cart.

Click [purchase other] to buy other software.

Note:

The operation for update center is the same as for the purchase center.

5 FAQ

X431Diagun is a hi-tech product. With the development of modern automotive industry, more and more new technology will be adopted and there may be questions during operation. Read the user's manual to get the answer whenever you have any question, or contact our Customer Service Center for help.

Here we list some frequently asked questions and answers relating to X431Diagun.

About Update via Internet

Question: Some downloaded diagnostic program is not listed in the update tool, what is the reason?

Answer: There are two possible causes:

1. The downloaded diagnostic program is not put in the same folder as other diagnostic programs. Please move it to the same folder as others.
2. The diagnostic program is not fully downloaded. Please download the program again.

Question: When the updated software is used in vehicle diagnosis, some diagnostic program can not be downloaded successfully from the TF card. Why?

Answer: possible causes and solutions:

1. The Display Program may have not been updated. Please update the Display Program.
2. The diagnostic program for the vehicle make is damaged. Please re-download the diagnostic program and update.

About Hardware

Question: Why does the LCD screen respond so slowly?

Answer: It is because the ambient temperature is close to the lower limit of operating temperature range (0-50°C). In this situation, it is necessary to warm up the machine for 20 minutes before test.

Question: There is no character on the backlit screen. What should I do?

Answer: Check if the power is well connected. Turn off the machine, unplug the power connector and re-plug it. Turn on the machine after it has been connected to the power for 1 second.

Question: Why does X431Diagun fail in communication with ECU?

Answer: Please make sure that the diagnostic connector and diagnostic program are matching vehicle make.

Question: The screen keeps blank after flashing when the machine is turned on. What should I do?

Answer: Take out the TF card and re-start the machine to see if there is normal display. If the display is normal when the TF card is taken out, the TF card should be replaced. If the screen is still blank, please contact the local service engineer.

Question: Why can't the data be inputted after Soft Keyboard is activated?

Answer: The position where the cursor lies can't be edited. Or you have not activated the cursor on the input position. Please use the stylus to click the part to edit. When the cursor twinkles, you can input the data.

Question: Why does the saved data disappear?

Answer: There are two possible causes:

1. Your TF card is damaged.
2. You've changed language and the data is related to language. You may find the data after switching back to the former language.

Question: The screen does not respond or responds wrongly when I click it with stylus. What should I do?

Answer: It is necessary to calibrate the screen. Please refer to the section 2.5.2 in User's Manual.

Question: What can I do when the screen is confused?

Answer: Please quit the current application (interface), and run it again. If the problem still exists, please restart the system.

About System Setting

Question: The screen is inactive after the cross cursor appears on the screen. Why?

Answer: The system is calibrating the touch screen. The machine will work after the screen is calibrated. Refer to the section 2.5.2 in User's Manual.

Question: The screen does not respond or responds wrongly when I click it with stylus. What should I do?

Answer: It is necessary to calibrate the screen. Please refer to the section 2.5.2 in User's Manual.

Question: The time displayed in the bottom right-hand corner of the screen is incorrect. How to adjust it?

Answer: It is because the time was set incorrectly. Please refer to the

section 2.5.3 in User's Manual to set correct time.

About Operation

Question: System halts when reading data stream. What is the reason?

Answer: It may be caused by a slackened connector. Please turn off the machine, firmly connect the connector, and switch on the machine again.

Warranty

THIS WARRANTY IS EXPRESSLY LIMITED TO PERSONS WHO PURCHASE LAUNCH PRODUCTS FOR PURPOSES OF RESALE OR USE IN THE ORDINARY COURSE OF THE BUYER'S BUSINESS.

LAUNCH electronic product is warranted against defects in materials and workmanship for one year (12 months) from date of delivery to the user.

This warranty does not cover any part that has been abused, altered, used for a purpose other than for which it was intended, or used in a manner inconsistent with instructions regarding use. The exclusive remedy for any automotive meter found to be defective is repair or replacement, and LAUNCH shall not be liable for any consequential or incidental damages.

Final determination of defects shall be made by LAUNCH in accordance with procedures established by LAUNCH. No agent, employee, or representative of LAUNCH has any authority to bind LAUNCH to any affirmation, representation, or warranty concerning LAUNCH automotive meters, except as stated herein.

Disclaimer

THE ABOVE WARRANTY IS IN LIEU OF ANY OTHER WARRANTY, EXPRESSED OR IMPLIED, INCLUDING ANY WARRANTY OF MERCHANTABILITY OR FITNESS FOR A PARTICULAR PURPOSE.

Order Information

Replaceable and optional parts can be ordered directly from your LAUNCH authorized tool supplier. Your order should include the following information:

1. Quantity
2. Part number
3. Item description

Customer Service

If you have any questions on the operation of the unit, please contact us:

Tel: 86-755-84528431/84528822

E-mail: X431@cnlaunch.com

If your unit requires repair service, return it to the manufacturer with a copy of the sales receipt and a note describing the problem. If the unit is determined to be in warranty, it will be repaired or replaced at no charge. If the unit is determined to be out of warranty, it will be repaired for a nominal service charge plus return freight. Send the unit pre-paid to:

Attn: Customer Service Department
LAUNCH TECH. CO., LTD.
Launch Industrial Park,
North of Wuhe Avenue,
Banxuegang, Bantian,
Longgang, Shenzhen, Guangdong
P.R.China, 518112